



# **SimplyGo Mini**

---

## *User manual*

**Thank you for choosing an Oxycure concentrator.**



## **Oxygen therapy**

### Oxycure portable oxygen concentrator

- Oxycure oxygen concentrator – Inogen G3
- Oxycure oxygen concentrator – Inogen G4
- Oxycure oxygen concentrator – Inogen G5
- Oxycure oxygen concentrator – SimplyGo Mini
- Oxycure oxygen concentrator – SimplyGo
- Oxycure oxygen concentrator – Eclipse 5
- Oxycure oxygen concentrator – Zen-O lite
- Oxycure oxygen concentrator – Zen-O (not in the picture)

### Oxycure Stationary oxygen concentrator

- Oxycure oxygen concentrator – Kröber

### Oxycure cylinders (gaseous oxygen)

- Oxycure B2 cylinder – 0.4 m<sup>3</sup>
- Oxycure B5 cylinder – 1.0 m<sup>3</sup>
- Oxycure B10 cylinder – 2.1 m<sup>3</sup> (not in the picture)

### Oxycure tanks (liquid oxygen)

- Oxycure liquid oxygen tank – 26 m<sup>3</sup>
- Oxycure portable liquid oxygen tank (1.0 m<sup>3</sup>)

## **Sleep apnea**

- S.Box - Sefam

**More information at [www.oxycure.be](http://www.oxycure.be)**



**OXYCURE : ORDERS****081 22 15 90**

Oxycure plc.  
Business Park Fernelmont  
L. Génicot, 9  
B-5380 Fernelmont  
Belgium  
Tel + 32 (0)81 22 15 90 Fax  
+ 32 (0)81 22 15 99

<http://www.oxycure.be>  
e-mail : [oxycure@oxycure.be](mailto:oxycure@oxycure.be)

**OPENING HOURS**

From Monday to Friday

09.00 – 12.30 and 13.30 – 18.00

**CUSTOMER SERVICE****0800 98 0 68**

Our customer service operates 24/7.

It is exclusively to urgent installations or repairs on our medical devices.

**Call to guard service**

1. Leave a message on the answering machine with your name and phone number and give a brief reason of your call ;
2. The customer service will call you within 20 minutes ;
3. If the customer service did not call you within 20 minutes, call again.

**Notes**

1. Technical interventions (repairs) are included in the price of the assistance of the leasing.
2. Deliveries of goods, outside the opening hours, will be charged.

# Table of Contents

---

Introduction .....	1
Intended Use.....	1
Contraindications.....	1
Device and Accessories Description.....	1
SimplyGo Mini System .....	2
Warnings and Cautions.....	3
Symbol Key.....	7
How to Contact Philips Respironics.....	7
Getting Started.....	8
System Overview.....	8
Standard and Extended Rechargeable Lithium-Ion Batteries.....	10
Inserting and Removing the Batteries .....	10
Charging the Battery with the AC Power Supply.....	12
Operating the SimplyGo Mini Device .....	13
Power Options.....	13
Device Warm-Up.....	14
Setting up the Cannula and Tubing .....	14
Powering On the Device.....	16
Powering Off the Device.....	17
Device Display Backlight .....	17
Navigating the Display Screens .....	17
Viewing and Changing Settings .....	18
Home Screen.....	18
Alarm Indicators and Screen Symbols.....	25
How to Mute and Unmute an Alarm .....	25
How to Scroll through the Alarm Screens.....	25
Troubleshooting.....	35
Caring for your Battery .....	36
Battery Storage .....	36
Caring for your SimplyGo Mini System .....	37
Cleaning the Device and Rechargeable Battery.....	37
Cleaning the Accessories.....	38
Device Storage .....	38
Device Disposal.....	38
SimplyGo Mini Portable Oxygen Concentrator Mobility .....	39
SimplyGo Mini Carrying Case.....	39
Traveling With Your System .....	41
By Motor Vehicle.....	41
By Bus or Train .....	42
On Arrival.....	42
Specifications.....	43
Standards Compliance .....	45
Classification .....	46
EMC Information.....	47
Limited Warranty.....	49

# Introduction

---

## Intended Use

The Philips Respironics SimplyGo Mini Portable Oxygen Concentrator is for prescription use by patients requiring high concentrations of oxygen on a supplemental basis. It is small, portable, and is capable of continuous use in the home, institutional, and travel /mobile environments.

## Contraindications

- This device is not intended to be life-sustaining or life-supporting.
- This device is not intended for newborn and infant use.

## Device and Accessories Description

The SimplyGo Mini Portable Oxygen Concentrator, its features, and its accessories are described in detail in this manual. Read and understand it completely before operating the device.

This manual applies to the following accessories:

- AC Power Supply
- AC Power Cord
- DC Power Supply
- Rechargeable Lithium Ion Standard and Extended Batteries
- Carrying Case
- Accessory Bag

This manual does not apply to the following accessory items sold separately:

- Standard Single Lumen Nasal Cannula
- Battery Charger
- SimplyGo Mini Backpack

## SimplyGo Mini User Manual

# SimplyGo Mini System

The device comes with the following items. If any are missing, contact your equipment provider.

- SimplyGo Mini Device in Carrying Case with Shoulder Strap

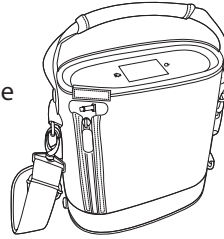

- This User Manual

- Standard or Extended Rechargeable Batteries

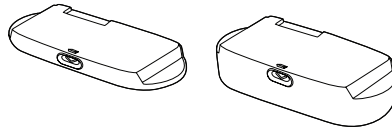

- AC Power Supply and Cord

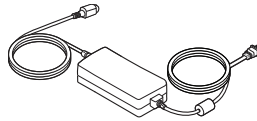

- DC Power Supply

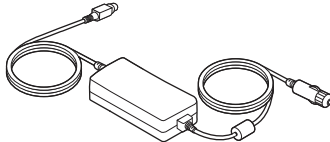

- Accessory Bag



## Warnings and Cautions

### Warnings

A warning represents the possibility of harm to the operator or patient.

- The operator should read and understand this entire manual before using the device.
- The device is not intended for life support. Where the prescribing health care professional has determined that an interruption in the supply of oxygen, for any reason, may have serious consequences to the user, an alternate source of oxygen should be available for immediate use.
- Geriatric or any other patient unable to communicate discomfort, or hear or see the alarms while using this device, may require additional monitoring.
- If you feel discomfort or are experiencing a medical emergency while undergoing oxygen therapy, seek medical assistance immediately to avoid harm.
- The oxygen delivery settings of the oxygen concentrator should be periodically reassessed for the effectiveness of the therapy.
- Set the device at the prescribed level and do not increase or decrease your flow rate from the prescribed level until you first consult with your physician or healthcare professional.
- Oxygen supports combustion. Oxygen should not be used while smoking or in the presence of an open flame.
- Do not use the device in the presence of a flammable anesthetic mixture in combination with oxygen or air, or in the presence of nitrous oxide.
- Do not use oil or grease on the concentrator or its components as these substances, when combined with oxygen, can greatly increase the potential for a fire hazard and personal injury.
- Only use this device as prescribed. The use of oxygen therapy can be hazardous in some circumstances, so consult your health care practitioner before using the SimplyGo Mini device.
- To ensure that you receive the correct therapeutic amount of oxygen delivery according to your medical condition, the Philips Respironics SimplyGo Mini device must be used:
  - Only after one or more settings have been individually determined or prescribed for you at your specific activity levels

## SimplyGo Mini User Manual

### Warnings (continued)

- With the specific combination of parts and accessories that are in line with the specification of the oxygen concentrator manufacturer and that were used while your settings were determined
- Some respiratory efforts of the patient might not trigger the SimplyGo Mini concentrator.
- The settings of the Philips Respironics SimplyGo Mini device might not correspond with continuous flow oxygen.
- The settings of other models or brands of oxygen therapy equipment do not correspond with the settings of the Philips Respironics SimplyGo Mini device.
- Use only water-based lotions or salves that are oxygen compatible during setup or use during oxygen therapy. To avoid the risk of fire and burns, never use petroleum or oil-based lotions or salves.
- If you notice any of the following, discontinue use and contact your equipment provider (i.e., Durable Medical Equipment (DME and Home Care Providers (HCP):
  - unexplained changes in the performance of this device
  - unusual or harsh sounds
  - dropped or mishandled device or the power supply
  - water spilled into the enclosure
  - broken enclosure
- Oxygen makes it easier for a fire to start and spread. Do not leave the nasal cannula on bed coverings or chair cushions if the oxygen concentrator is turned on, but not in use; the oxygen will make the materials flammable. Turn the oxygen concentrator off when not in use.
- To ensure proper function and to avoid the risk of fire and burns:
  - Use only with Philips Respironics SimplyGo Mini AC power supply.
  - Use only with Philips Respironics SimplyGo Mini batteries.
  - Use only approved SimplyGo Mini accessories.
- Incompatible parts or accessories can result in degraded performance.
- Repairs and adjustments must be performed by Philips Respironics authorized service personnel only. Unauthorized service could cause injury, invalidate the warranty, or result in costly damage.



## SimplyGo Mini User Manual

- Periodically inspect electrical cords, cables, and the power supply for damage or signs of wear. Discontinue use and replace if damaged.
- To avoid electric shock, unplug the device and remove the batteries before cleaning the bag. DO NOT immerse the device in any fluids.
- For proper operation, your device requires unobstructed ventilation. Always make sure any openings in the case are not obstructed by items which may impede ventilation. Do not place the device in a small closed space (such as a closet). The device should not be used adjacent to or stacked with other equipment. For more information, contact your equipment provider.
- Do not use an extension cord.
- Device operation above or outside of the voltage, breath rate, temperature, humidity and/or altitude values specified may decrease oxygen concentration levels.
- Be aware that the electrical cord and/or tubing could present a tripping or strangulation hazard.
- Use only power cords supplied by Philips Respironics for this device. Use of power cords not supplied by Philips Respironics may cause overheating or damage to the device and may result in increased emissions or decreased immunity of the equipment or system.
- Do not operate without the battery installed and working. If primary power is lost with no battery in place, the device will stop operating without warning the user. If the device must be operated without the battery, the user should be aware that there is no backup power and no warning if primary power is lost.
- If the SimplyGo Mini device will not be used for a long period of time, remove the battery from the device.
- Place the device in a location so as to avoid pollutants and fumes.
- Do not modify this system or equipment in any way. Modifications could result in hazards to the user.

## Cautions

A caution represents the possibility of damage to the equipment.

- Your equipment provider is responsible for performing appropriate preventive maintenance at the intervals recommended by Philips Respironics.
- Never drop or insert any object into any opening.
- Do not immerse the device or allow any liquid to enter the enclosure.

## SimplyGo Mini User Manual

- When the device is used in an automobile, disconnect it from the DC auto adapter outlet when the automobile is turned off. Do not operate the device in a non-running vehicle for an extended period of time, as this may deplete the vehicle's battery and prevent the vehicle from starting. Do not allow the device to be connected to the auto adapter outlet while starting the automobile normally or while you are starting the automobile with battery recharging cables. Wait until the automobile starts before connecting the device to the DC power outlet. Secure the device whenever it is used in any moving vehicle. (The same cautions apply if using the DC adapter outlet on a boat or recreational vehicle.)
- Turn off the device before removing the battery. The device should not be operated without the batteries installed. If the device is operated without the batteries installed, the standard shut-down routine will not be implemented when the power is disconnected prior to turning off the unit. This can result in damage to the device.
- Only use the supplied handle and shoulder strap to carry your device. With every use, verify that the case, shoulder strap and handle are in good condition.
- Medical Electrical Equipment needs special precautions regarding EMC and needs to be installed and put into service according to the EMC information provided in this manual.
- Portable and Mobile RF Communications Equipment (including peripherals such as antenna cables and external antennas) should be used no closer than 30 cm (12 inches) to any part of the SimplyGo Mini device or system, including cables specified by the manufacturer. Otherwise, degradation of the performance of this equipment could result.
- The use of cables and accessories other than those approved for use by Philips Respironics may negatively affect EMC performance.

**Note:** Additional warnings, cautions, and notes are located throughout the manual.

## Symbol Key



Consult accompanying instructions for use



Model number



No smoking



Serial number



No oil or grease



Type BF Applied Part



Keep away from open flames



Rechargeable Battery



Do not disassemble



Drip proof equipment



DC power



AC Power



Separate collection for electrical and electronic equipment per EC Directive 2012/19/EU.



Class II (Double Insulated)

**Note:** Also see the section on alarm indicators and screen symbols.

## How to Contact Philips Respironics

To have your device serviced, contact your equipment provider. If you need to contact Philips Respironics directly, call the Customer Service department at 1-724-387-4000 or +49 8152 93060. You can also use one of the following addresses:

Respironics Inc.  
1001 Murry Ridge Lane  
Murrysville, PA 15668 USA

Respironics Deutschland  
Gewerbestr. 17  
82211 Herrsching, Germany

## SimplyGo Mini User Manual

# Getting Started

Attach the shoulder strap to the carrying case.

Before using the SimplyGo Mini device for the first time, the SimplyGo Mini standard or extended batteries require an initial uninterrupted charging time of 3.5 hours minimum for the standard and 7 hours minimum for the extended battery. This can be accomplished by installing the battery and using the AC Power Cord, as described in the following pages. Or optionally, you can use the Smart Battery Charger to charge the SimplyGo Mini batteries.

**Note:** Philips Respironics does not recommend using DC power for this initial charging.

**Warning:** Use only Philips Respironics batteries in your SimplyGo Mini device. Using other batteries could damage the device and will void the warranty. Remove the battery if the SimplyGo Mini will not be used for an extended period of time.

## System Overview

Begin by becoming familiar with your SimplyGo Mini device.

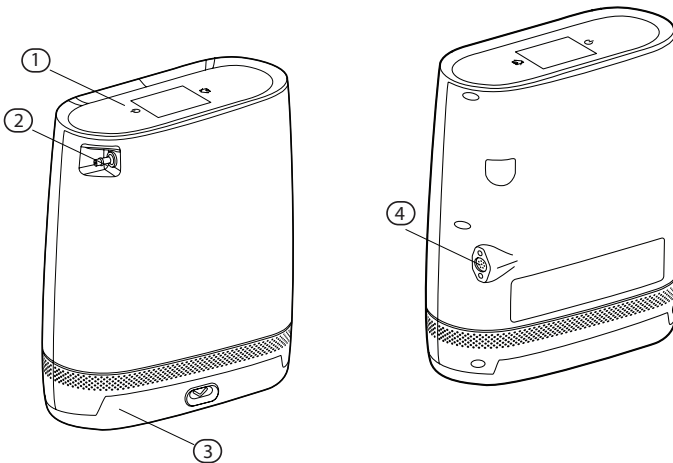

Item	Description	Function
1	Control Panel	Touchscreen interface to control all functions of the concentrator

**SimplyGo Mini User Manual**

2	Patient Cannula Connector	Oxygen output and connection point for patient cannula
3	Rechargeable Battery	Standard or extended rechargeable lithium-ion battery
4	Power Input Connector	Connection point for Philips Respironics-provided external power supplies: AC line voltage, vehicle DC

**Control Panel**

Item	Description	Function
1	Power Button	Turns the device On and Off
2	Display Screen	Shows information about the operating status of the device and device settings
3	Home Button	Accesses the Home screen from any screen

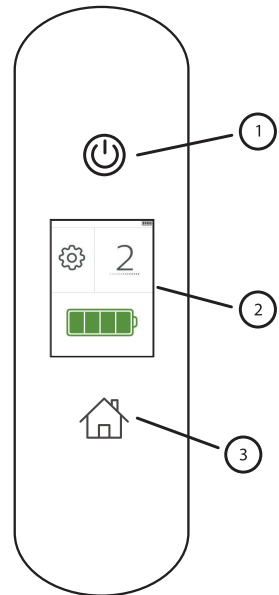

## SimplyGo Mini User Manual

# Standard and Extended Rechargeable Lithium-Ion Batteries

You can use a rechargeable battery to power the SimplyGo Mini without connection to an external power source. When fully charged, the standard battery will provide up to 4.5 hours of operation and the extended battery will provide up to 9 hours of operation when on setting 2.

**Note:** Battery duration times will degrade with battery age, environmental operating conditions, and use over time. To maximize battery life, please see the *Caring for Your Battery* section of this manual. If the battery is near the end of its useful life, you may experience battery durations of approximately two-thirds that of a new device.

## Inserting and Removing the Batteries

You can use a standard battery or extended battery with your SimplyGo Mini device. They are inserted using the same method. To insert the batteries, complete the following steps:

1. Place your device in a well-ventilated location and make sure it is turned off.

**Note:** The SimplyGo Mini device is shipped from the factory with the battery removed.

2. Hold the SimplyGo Mini device in one hand, and use your other hand to insert the battery compartment into the bottom of the SimplyGo Mini as shown in the following illustration.

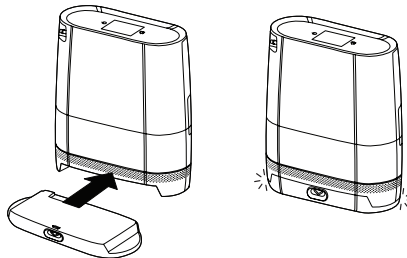

**Caution:** Only remove the battery when the SimplyGo Mini is turned off. Never remove the battery while the device is operating.

**SimplyGo Mini User Manual**

3. To remove the standard or extended battery, push the eject button on the center of the battery compartment down as shown in the following illustration. The battery will release from the device. If the device has been operating, the surfaces may be warm to the touch. This is normal.

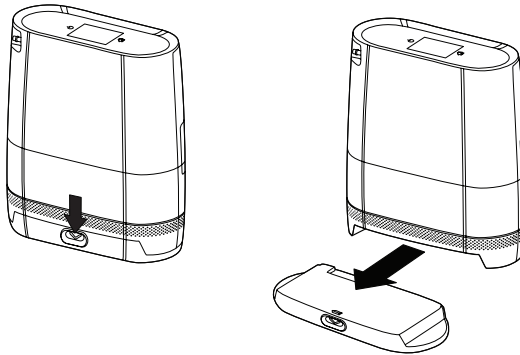

4. When the standard or extended battery is not installed, you can check the battery gauge on the battery to determine the amount of charge available.

Determine the amount of battery charge available by pressing the black button(s) and observing how many LEDs illuminate. The Extended Battery has two independent battery cells, two buttons, and two independent LED battery charge indicator gauges. Recharge the batteries if they are low. See the *Charging the Battery with AC Power Supply* section.

<b>Number of LEDs</b>	<b>Battery Charge</b>
4 LEDs Light:	75% to 100% full
3 LEDs Light:	50% to 75% full
2 LEDs Light:	25% to 50% full
1 LED Lights:	10% to 25% full
1 LED Blinks 3 Times:	Battery is less than 10% full and needs to be recharged

## SimplyGo Mini User Manual

# Charging the Battery with the AC Power Supply

**Important:** The first time you charge the battery, be sure to charge it fully. Do not use the DC power cord to do so; instead use AC power.

**Note:** The battery will begin charging whenever you connect the device to an AC outlet, regardless of whether or not it is in use.

To charge the battery using the AC Power Cord provided with your system, follow these steps.

1. Connect the AC Power Supply's output cable to the SimplyGo Mini power input connector.
2. Connect the AC Power Cord's connector into the AC power supply.
3. Connect the AC Power Cord's plug into an AC outlet installed to meet national or regional electrical code.

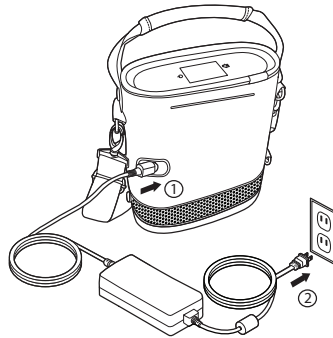

**Note:** The AC Power Supply is equipped with a green light, which illuminates as soon as you connect the device to an energized AC power source.

4. When charging is complete (this takes four hours or less for the standard battery), disconnect the AC Power Supply and store it with the AC Power Cord for future use.

**Note:** Replacement and spare batteries are available separately. For information, contact your equipment provider.

**Note:** An optional SimplyGo Mini Smart Battery Charger (sold separately) is available for your system. For more information, contact your equipment provider.



# Operating the SimplyGo Mini Device

---

## Power Options

**Warning:** Do not use the device without the battery installed and operating.

- To run the device on battery power, make sure the battery is properly inserted and sufficiently charged. (The battery should be fully charged the first time you use it.)
- **To run the device using AC power**, first make sure you have a battery installed. Then, follow these steps:
  1. Connect the output cable of the AC Power Supply to the SimplyGo Mini power input connector.
  2. Connect the AC Power Cord's connector into the AC power supply.
  3. Connect the AC Power Cord's plug into an AC outlet installed to meet national or regional electrical code.
- **To run the device using DC power** from an automobile or other motorized vehicle, make sure the battery is installed. Start the vehicle and connect one end of the DC Power Cord to the device's power inlet and the other end into the vehicle's DC electrical outlet.

**Note:** DC power provided by the DC Power Supply will also charge the battery when the device is turned off or is running on setting 1, 2, or 3. It may not charge the battery when the device is running on setting 4 or 5. Charging status can be verified with the battery icon on the Home Screen.

**Note:** Battery duration times will degrade with battery age, environmental operating conditions, use over time, and operational condition of the concentrator. To maximize battery life, please see the Caring for Your Battery section of this manual. If the battery is near the end of its useful life, you may experience battery durations of approximately two-thirds that of a new battery.

## SimplyGo Mini User Manual

### Device Warm-Up

When you turn on your SimplyGo Mini device, it will sense if you are breathing from it. If you are not yet breathing through the cannula, SimplyGo Mini will begin to pulse automatically about once every five seconds. As soon as you begin breathing through the cannula, the device will begin delivering pulses based on your breathing. It may take up to 20 minutes for the SimplyGo Mini output to stabilize within its O<sub>2</sub> purity specifications. However, you may begin breathing from the SimplyGo Mini at any time. During the initial stabilization period, the Warm-Up symbol is displayed under the setting number.

### Setting up the Cannula and Tubing

The alarm system should be verified before use by the equipment provider and between users by service personnel in accordance with the SimplyGo Mini service manual.

However, the user may verify the functionality of the alarm system as follows:

1. Induce a No Flow Alarm condition by turning the device ON and completely blocking the patient cannula connector of the device.
2. Wait approximately 90 seconds or until the No Flow Alarm occurs.
3. Verify that the No Flow Alarm indicators and screen symbols are present.
4. Unblock the patient cannula connector for a minimum of 60 seconds.
5. Verify that the No Flow Alarm ceases.

**SimplyGo Mini User Manual**

To set up the SimplyGo Mini device, follow these steps.

1. Connect a nasal cannula to the patient cannula connector on the device, as shown. Ensure that the cannula is routed to prevent it from being pinched or kinked to avoid a disruption of oxygen flow.

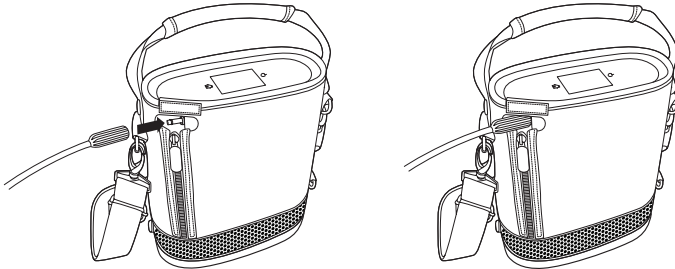

**Note:** A standard single lumen nasal cannula and tubing (not supplied) should be used to deliver oxygen from the SimplyGo Mini device. The device works with cannula tubing up to 10 ft. (3 m). The proper placement and positioning of the nasal cannula in the nose is critical to the consistent operation of the SimplyGo Mini.

2. Power on the device as described in the next section.
3. Position the nasal cannula on your face, as shown below, and breathe normally through your nose.



## SimplyGo Mini User Manual

### Powering On the Device

1. You can press the Power button once or simply touch the black screen on the device to quickly view your settings. The screen shown here will appear with the following information displayed:
  - O<sub>2</sub> setting
  - Battery capacity
  - Number of hours the device has been used
  - Software version

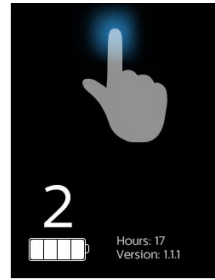

The screen will automatically shut off again after 5 seconds.

2. If you want to fully power on the device, press the Power button a second time, within 5 seconds of the first press. This second press helps prevent unwanted starts or inadvertent changes in oxygen flow. The Philips Respironics splash screen appears briefly followed by the Home screen, both shown below.

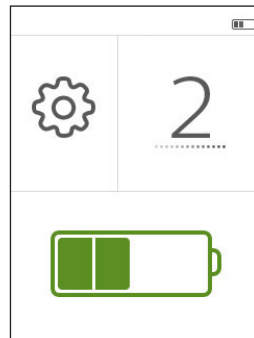

Every time it starts up, the device starts producing oxygen to meet the specified setting. It may take up to 20 minutes to reach the specified purity levels for the setting. It is safe to begin breathing from the SimplyGo Mini device immediately. Breathing from the device will cause it to reach oxygen purity levels faster.

**Note:** When it is turned on, the device will automatically start at the oxygen flow rate setting used when the device was last turned off. As a precaution, each time you start the device, verify the flow setting.

## Powering Off the Device

1. To turn the device off, press the Power button and the confirmation screen shown here appears.
2. Press the Power button a second time to turn the device off.

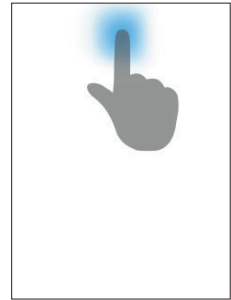

**Note:** If you do not press the Power button a second time, the screen will return to the Home screen.

## Device Display Backlight

The device features a backlight that turns on automatically whenever:

- You touch the screen
- An alarm occurs
- The device is plugged into an external power supply
- A battery is inserted into the device

The backlight automatically shuts off after one minute of inactivity, as a power-saving feature.

## Navigating the Display Screens

As you access each of the display screens, there are some common actions you can take to move from screen to screen, adjust settings, return to a previous screen, etc.

- Press the Home button () from any of the display screens if you want to quickly return to the Home screen.
- If a screen has + and - buttons at the bottom, press those to scroll through setting selections and choose the desired setting.
- The Device Tools menus may also have < and > buttons at the bottom. Press these to scroll back and forth through the items you want to modify, and select the data you need to change.

**Note:** If you've reached the limit for a setting, then the < or > buttons will appear gray on the screen and will be disabled.

- The Device Tools menus may also have an  in the top left corner of the screen. Press that arrow to return to the previous screen.

## SimplyGo Mini User Manual

# Viewing and Changing Settings

This section describes how to view and change settings on the SimplyGo Mini device.



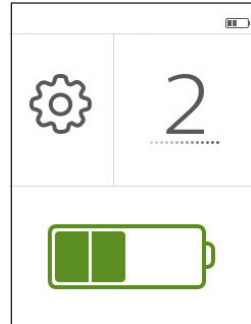

## Home Screen

The Home screen shown here contains three main items:







- Tool icon
- Flow Setting
- Battery Charge Level



The following symbols appear on the Home screen.

SYMBOL	DESCRIPTION
	The Tool icon provides access to the Device Tools menu.
	The Pulse symbol features dotted animation under the setting value to indicate that the device detected a breath and delivered a pulse of oxygen.
	The Warmup symbol indicates to the user that the O <sub>2</sub> purity has not yet been sampled because the system needs to stabilize. Its duration is at least 14 minutes.
	The Maximum Volume symbol indicates that the device is providing the maximum volume of oxygen for the current setting.
	The battery charge level symbols indicate the amount of charge left on the battery in use. For a complete list of battery charging symbols, see the "Checking the Battery Status" section later in this manual.

Additionally, the Status bar at the top of the screen displays the following:

SYMBOL	DESCRIPTION
	This yellow symbol indicates that the device has detected an active alarm.
	This symbol indicates that an active alarm has been silenced but not resolved.
	This green symbol indicates that a battery is installed in the device, and AC power is also connected.
	This green symbol indicates that AC power is connected but no battery is installed.
	This symbol indicates the battery level (about 50% in this example). Refer to the Checking the Battery Status section of this manual for more details.
	This yellow symbol indicates that the battery level is low.
	This yellow symbol indicates that the battery level is depleted.

## Changing the O<sub>2</sub> Flow Setting

To change the O<sub>2</sub> flow setting, complete the following steps:

1. Touch the O<sub>2</sub> number shown on the Home screen to access the O<sub>2</sub> Settings screen, shown below.

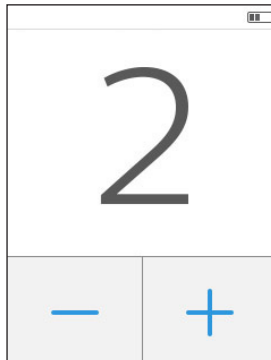

## SimplyGo Mini User Manual

2. Press the + or - buttons to increase or decrease the O<sub>2</sub> setting as needed. You can adjust the setting from 1 to 5 in increments of 1.

**Note:** When you've reached the setting limit, the + or - symbols will be greyed out to indicate that they are disabled and can no longer be selected.

The device detects when the user begins to take a breath and then delivers a pulsed volume of oxygen during the inhalation period. The volume of the oxygen pulse is dependent on the setting value. If no breath is detected for a period of time, the system automatically delivers the pulsed volume of oxygen determined by the setting number at a fixed rate of 12 breaths per minute. If no breath is detected for 2 minutes, the device signals an alarm and shuts down after 15 minutes if the device is running on battery power.

## Checking the Battery Status

To check the battery status, complete the following steps:

1. Touch the battery symbol on the Home screen to access the Battery Information screen, shown below.

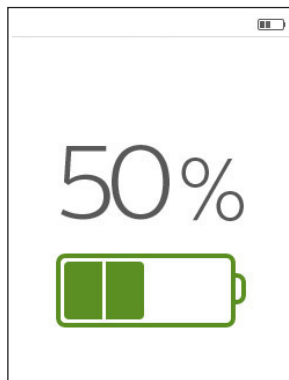









The battery percentage number appears on the screen to indicate how much battery capacity is left, and the battery level symbol appears below the number.



**SimplyGo Mini User Manual**

The following table describes each of the battery symbols:

<b>SYMBOL</b>	<b>DESCRIPTION</b>
	Battery level at 25%
	Battery level at 50%
	Battery level at 75%
	Battery level at 100%
	Battery charging or battery charge complete and external power source still connected <b>Note:</b> The green battery bar blocks will scroll while the battery is charging and this symbol appears. Once fully charged, the battery blocks stop scrolling and one long beep sounds.
	Low battery - indicates battery level is almost depleted
	Battery depleted
	AC power connected; no battery installed (green)
	External power failure; no battery installed (yellow)

## SimplyGo Mini User Manual

### Accessing the Device Tools Menu

There are three device tool menus:

- Brightness menu
- Alarm Log menu
- Language Selection menu

To access the Device Tools menu, complete the following steps:

#### Change the Brightness Setting

1. Touch the Tool icon (  ) on the Home screen to access the Device Tools Menu. The Brightness menu screen appears first, shown below.

**Note:** You can use the < and > buttons to scroll between the Brightness Menu and the Alarm Log menu if desired.

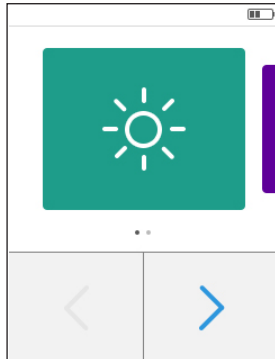

2. Press on the Brightness icon to access the Brightness setting screen, shown below.

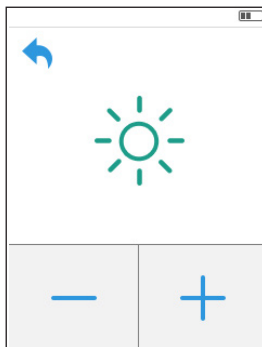

3. Press the + and - buttons to scroll through the three brightness settings and choose the desired brightness.

**Note:** If you want to exit the Device Tools menu and return to the previous screen, press the arrow in the top left corner of the screen.

### Access the Alarm Log Menu

1. Press the  to return to the Tools menu, and press the < and > buttons to navigate to the Alarm Log menu, shown below.

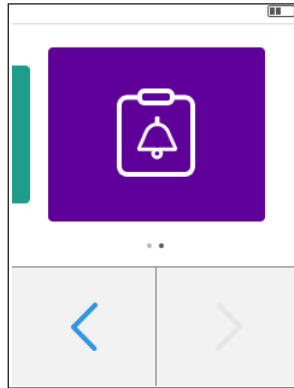

2. Press on the Alarm Log tile to access the screens shown below. If no alarms have ever occurred, the screen shown on the left will appear. Otherwise, a screen similar to the one on the right appears.

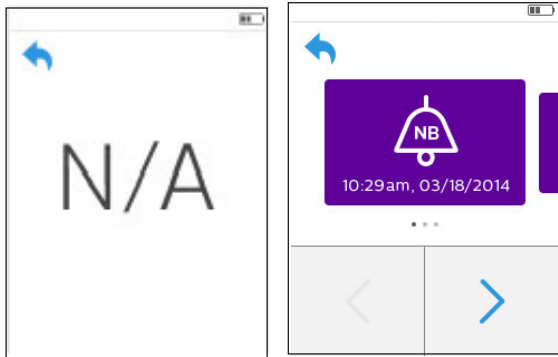

3. You can view the type of alarm that occurred and the start time and date of the alarm on the Alarm Log screen.
4. Press the < and > buttons to navigate through the list of alarms in the log history. The log will list the 16 most recent alarms.

## SimplyGo Mini User Manual

### Notes:

- The alarm log is maintained between device Power Off and Power On cycles (the time of Power Off is not logged).
- The most recent alarm events in the log from the current Power On session may be lost if the device experiences a total loss of power and improperly shuts down.
- The alarm log maintains the most recent 16 alarms and will discard the oldest data once its memory is full and a new alarm occurs. If less than 16 alarms have occurred, N/A will appear on some of the alarm screens.

### Change the Language Selection Setting

To select a new language on the SimplyGo Mini device, complete the following steps:

1. From the Home screen, click on the Tools icon to access the Device Tools menu.
2. Press the page left or page right (< >) buttons to scroll through the menus until the language selection menu appears, shown at right.
3. Press the Language Selection icon, and then press the up and down arrows (^ v) to scroll through the list until the desired language appears, as shown below.

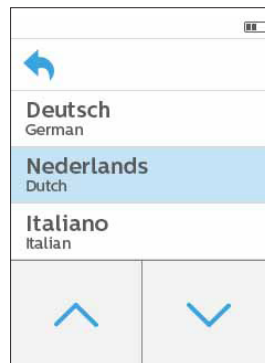
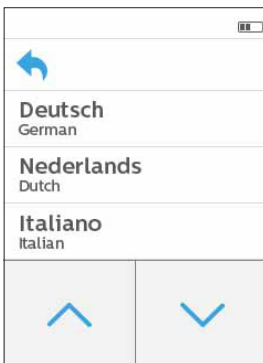
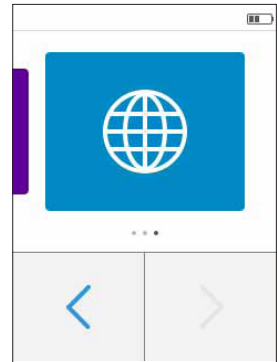

## SimplyGo Mini User Manual

4. Select the desired language to highlight it, and the confirmation screen will appear, shown at right.
5. Select the ✓ to confirm the language selection, or select the X to cancel the selection.

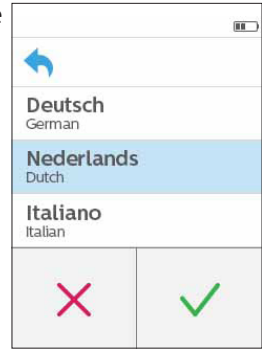

**Note:** If the X is pressed, the language selection will be cancelled.

6. When the language selection is confirmed, the screen will reboot and the device will return to the Home screen. Messages displayed on-screen will now be in the newly selected language.

## Alarm Indicators and Screen Symbols

**Note:** All SimplyGo Mini alarms are low priority alarms. The alarm system should be verified before use and between users by service personnel in accordance with the SimplyGo Mini service manual.

### How to Mute and Unmute an Alarm

To mute an active alarm:

- When an alarm appears on screen, press the yellow Mute control that appears on the alarm screen. The Mute control will then change to gray.

To unmute an active alarm:

- Press the gray Mute control on the alarm screen to unmute the alarm.

### How to Scroll through the Alarm Screens

Use the blue arrows in the top left and right corners of the alarm screens to scroll through the alarms.



**Note:** These arrows only appear when more than one alarm occurs simultaneously.



Click on the left blue arrow to go back to the previous alarm or click on the right blue arrow to go to the next alarm.

**Note:** If you are on the first alarm and there are no previous alarms, then only the blue arrow on the right will appear on screen. If you are on the last alarm and there are no more alarms to view, then only the blue arrow on the left will appear on screen, allowing you to scroll back through the previous alarms.

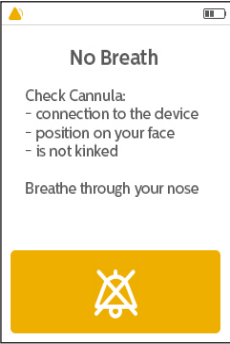

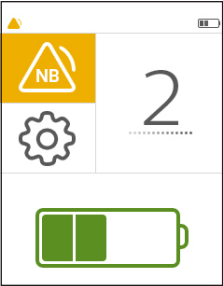
## SimplyGo Mini User Manual

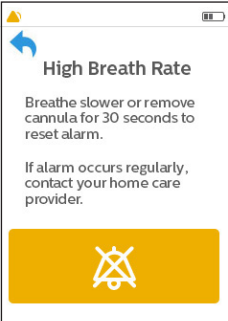
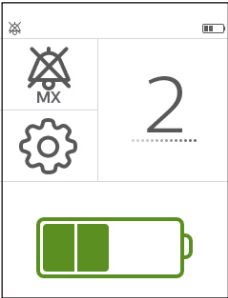
## Technical Alarms

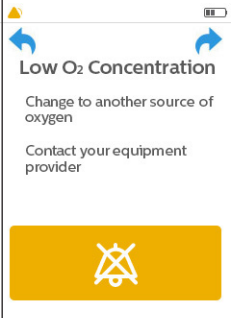
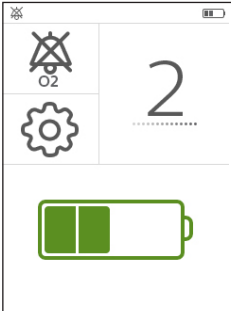

Visual, Audio Indicators	Description	What To Do
<p>1 beep that repeats every 16 seconds</p>   	<p><b>No Breath Alarm</b></p> <p>This alarm occurs when a breath is not detected for a period of 2 minutes or more. Press the yellow Alarm silence button on the screen to temporarily silence the alarm, and the 2nd screen shown at left appears. Or, press the Home button on the device to return to the Home screen, and the 3rd screen will appear with the No Breath (NB) alarm symbol in the upper left corner to indicate the active alarm state.</p> <p>This alarm resets itself as soon as a breath is detected. If the device is on battery power and no breath is detected after approximately 15 minutes, the device shuts down to conserve power. (This alarm is inactive for ten minutes after startup.)</p> <p><b>Note:</b> Upon startup, this alarm could take a maximum of 12 minutes to activate from the time the alarm condition is present. Otherwise, it can take up to 2 minutes to activate.</p>	<p>Check the connection from the cannula to the device.</p> <p>Make sure the nasal cannula is properly positioned on your face and that you are breathing through your nose.</p> <p>Make sure the cannula tubing is not kinked or obstructed.</p>

Visual, Audio Indicators	Description	What To Do
<p>1 beep that repeats every 16 seconds</p>   	<p><b>High Breath Rate Alarm</b></p> <p>This alarm indicates that the user's breath rate is exceeding the maximum pulse rate of the device. The device is still working properly and is still providing the maximum amount of oxygen for the user's setting.</p> <p>Press the yellow Alarm silence button on the screen to temporarily silence the alarm, and the 2nd screen shown at left appears. Or, press the Home button on the device to return to the Home screen, and the 3rd screen will appear with the High Breath Rate (MX) alarm symbol in the upper left corner to indicate the alarm state.</p> <p><b>Note:</b> This alarm could take up to 36 seconds to activate from the time the alarm condition is present.</p>	<p>The indicator resets itself when the breath rate is reduced. Breathe slower or remove the cannula for 30 seconds to reset the alarm.</p> <p>If this indicator regularly occurs, contact your equipment provider.</p>

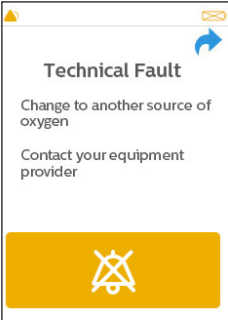
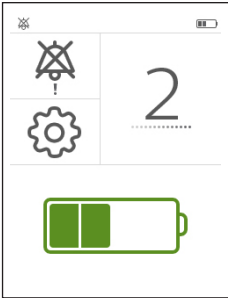

## SimplyGo Mini User Manual

Visual, Audio Indicators	Description	What To Do
<p>1 beep that repeats every 16 seconds</p>   	<p><b>Low Oxygen Concentration Alarm</b></p> <p>This alarm occurs when the device is delivering a lower concentration of oxygen than specified. Note: This alarm occurs when the internal O<sub>2</sub> sensor reads &lt;82% O<sub>2</sub>. It will turn off if the system is able to recover from the fault and achieve &gt;84% O<sub>2</sub>.</p> <p>Press the yellow Alarm silence button on the screen to temporarily silence the alarm, and the 2nd screen shown at left appears. Or, press the Home button on the device to return to the Home screen, and the 3rd screen will appear with the Low O<sub>2</sub> alarm symbol in the upper left corner to indicate the alarm state.</p> <p>If in normal operation, the internal oxygen sensor monitors O<sub>2</sub> purity during the warm-up period and then at 1 hour intervals after that.</p> <p><b>Note:</b> This alarm can take up to 61 minutes to activate from the time the alarm condition is present.</p>	<p>Change to another source of oxygen and contact your equipment provider.</p>



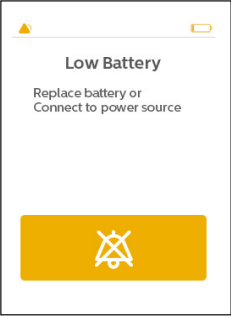
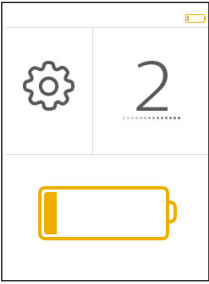

Visual, Audio Indicators	Description	What To Do
<p data-bbox="120 337 325 435">1 beep that repeats every 16 seconds</p>   	<p data-bbox="370 261 625 289"><b>Technical Fault Alarm</b></p> <p data-bbox="370 305 642 456">This alarm occurs when the device has a general malfunction and the device is no longer operating properly.</p> <p data-bbox="370 508 660 948">Press the yellow Alarm silence button on the screen to temporarily silence the alarm, and the 2nd screen shown at left appears. Or, press the Home button on the device to return to the Home screen, and the 3rd screen will appear with the Technical Fault alarm symbol in the upper left corner to indicate the alarm state.</p> <p data-bbox="370 1000 666 1122">The device may or may not shut down depending on the severity of the alarm.</p> <p data-bbox="370 1179 666 1393"><b>Note:</b> The amount of time it can take for the alarm to activate from the time the alarm condition is present will vary depending on the technical fault that occurs.</p>	<p data-bbox="713 808 926 959">Change to another source of oxygen and contact your equipment provider.</p>

## SimplyGo Mini User Manual

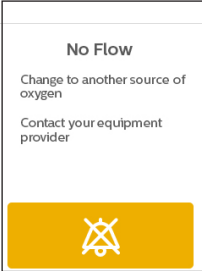
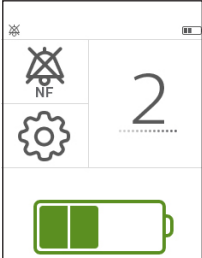

Visual, Audio Indicators	Description	What To Do
<p>1 beep that repeats every 16 seconds</p>  	<p><b>Low Battery Alarm</b></p> <p>This alarm occurs when approximately 10 minutes of battery life remains. Remaining battery life is dependent on your device settings and your activity level.</p> <p>Press the yellow Alarm silence button on the screen to temporarily silence the alarm, or press the Home button on the device to return to the Home screen, and the 2nd screen will appear with the Low Battery symbol flashing on the screen.</p> <p><b>Note:</b> This alarm could take up to 46 seconds to activate from the time the alarm condition is present.</p>	<p>Replace the battery or connect to a power source.</p>
	<p><b>Warm Up Indicator</b></p> <p>This symbol indicates to the user that the O<sub>2</sub> purity has not yet been sampled because the system needs to stabilize. Its duration is at least 14 minutes.</p>	<p>This symbol appears onscreen after initial startup and clears from the screen once the device has reached the minimum rated Oxygen Purity. Contact your equipment provider if it persists on screen for several hours after startup.</p>

**SimplyGo Mini User Manual**

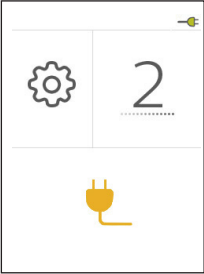
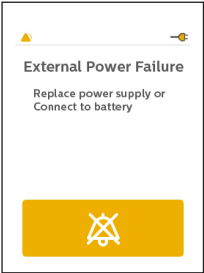

Visual, Audio Indicators	Description	What To Do
<p>1 beep that repeats every 16 seconds</p>   	<p><b>No Flow Alarm</b></p> <p>This alarm occurs when the device detects there is no oxygen flowing in the patient cannula.</p> <p>Press the yellow Alarm silence button on the screen to temporarily silence the alarm, and the 2nd screen shown at left appears. Or, press the Home button on the device to return to the Home screen, and the 3rd screen will appear with the No Flow (NF) alarm symbol in the upper left corner to indicate the alarm state.</p> <p><b>Note:</b> This alarm could take up to 66 seconds to activate from the time the alarm condition is present.</p>	<p>Check the cannula for kinks or other obstructions that are stopping oxygen flow through it.</p> <p>If alarm persists, change to another source of oxygen and contact your equipment provider.</p>

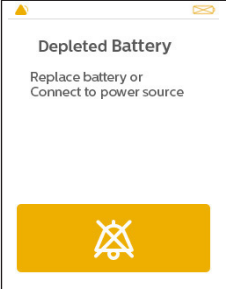
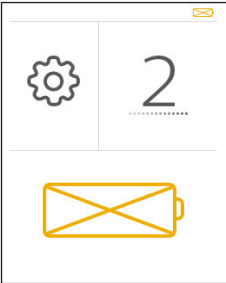
## SimplyGo Mini User Manual

Visual, Audio Indicators	Description	What To Do
<p data-bbox="120 282 325 378">1 beep that repeats every 16 seconds</p>  	<p data-bbox="356 287 625 345"><b>External Power Failure Alarm</b></p> <p data-bbox="356 362 676 578">This alarm occurs when there is an external power failure and no battery is installed. A yellow plug will appear on the Home Screen, shown at left, to indicate the external power fail.</p> <p data-bbox="356 631 655 751">Click on the Yellow Plug symbol and the External Power Failure alarm screen shown at left will appear.</p> <p data-bbox="356 807 658 990">Press the Alarm silence button on the screen to temporarily silence the alarm, or press the Home button on the device to return to the Home screen.</p>	<p data-bbox="701 282 948 370">Replace the power supply or connect the device to a battery.</p>

Visual, Audio Indicators	Description	What To Do
<p data-bbox="120 318 323 412">1 beep that repeats every 16 seconds</p>  	<p data-bbox="370 261 655 289"><b>Depleted Battery Alarm</b></p> <p data-bbox="370 302 634 423">This alarm occurs when approximately two minutes of battery life remains.</p> <p data-bbox="370 436 660 748">Press the yellow Alarm silence button on the screen to temporarily silence the alarm, or press the Home button on the device to return to the Home screen, and the 2nd screen will appear with the Depleted Battery symbol flashing on screen.</p> <p data-bbox="370 761 644 915"><b>Note:</b> This alarm could take up to 46 seconds to activate from the time the alarm condition is present.</p> <p data-bbox="370 928 625 1148"><b>Note:</b> The device will automatically power down if the battery remains depleted for more than 90 seconds and no external power source is connected.</p>	<p data-bbox="713 323 934 412">Replace the battery or connect to a power source.</p>
	<p data-bbox="370 1187 632 1214"><b>Alarm Silence Symbol</b></p> <p data-bbox="370 1227 666 1507">This yellow symbol appears when an event occurs that generates an audible alarm. Pressing this button will silence the audible alarm until a different alarm occurs or until you disable the alarm silence (see below).</p>	<p data-bbox="713 1289 937 1411">Refer to the associated alarm indicator also being displayed.</p>

## SimplyGo Mini User Manual

Visual, Audio Indicators	Description	What To Do
	<p><b>Alarm Symbol</b></p> <p>This gray symbol appears when you have pressed the alarm silence button. Pressing this button will enable the alarm audible.</p>	<p>Refer to the associated alarm indicator also being displayed.</p>
	<p><b>Attention</b></p> <p>This yellow symbol appears on the status bar when corrective action is required.</p>	<p>If the device is operating in the carrying case, make sure it has been placed correctly in the case so that the outlet vents are not blocked. See the <b>Carrying Case</b> section of this manual.</p> <p>Allow the device to warm up. If the alarm continues, contact your equipment provider.</p>
	<p><b>Flow Control Setting</b></p> <p>The large number on the screen shows the oxygen flow setting (in this example, it is 2). This number can range from 1 to 5 in increments of 1.</p>	<p><b>If this is your flow setting</b>, no action is needed.</p> <p><b>If this is not your flow setting</b>, press the + button to increase this number or press the - button to decrease the number.</p>

## Troubleshooting

---

The table below lists common problems and actions you can take. If you are unable to resolve a problem, please contact your equipment provider.

<b>Problem</b>	<b>Possible Cause</b>	<b>What You Should Do</b>
Device Won't Turn On	Battery is depleted.	Use the AC or DC power cords to operate the device (with the battery inserted) to recharge the battery. If this does not resolve the problem, contact your equipment provider.
	Battery is not installed correctly.	Remove the battery and re-install it correctly.
	Power button not pressed twice.	Press the power button twice.
Device Will Not Trigger A Pulse Of Oxygen	SimplyGo Mini is not turned on.	Press the power button twice.
	Cannula tubing is kinked or twisted.	Make sure the tubing is connected properly to the oxygen outlet port and that it is free of any obstruction.
	Device malfunction.	Contact your equipment provider.
Oxygen Not At Full Concentration	Device is warming up.	Continue using your device, and wait 20 minutes for the device to deliver oxygen at the prescribed concentration. If the condition persists, contact your equipment provider.
Alarm Occurs	The device needs your attention.	See the Alarm Indicators and Screen Symbols section for information about specific alarms and what you should do.

## SimplyGo Mini User Manual

# Caring for your Battery

---

Handle your battery with care.

- Do not allow the battery's terminals to touch together as this will cause it to fail.
- Do not immerse the battery in water.
- Do not disassemble or deform the battery.
- Do not expose to, or dispose of, the battery in fire.
- Avoid exposing the battery to excessive physical shock or vibration (dropping, etc.).
- Keep all batteries out of the reach of children.
- Do not use any battery that has been damaged in any way.
- Always charge the battery in accordance with the manufacturer's instructions, using specified chargers only.
- Do not use modified battery chargers.
- An optional, external charger can be purchased to charge the batteries. Contact your equipment provider for more information.

## Battery Storage

Lithium ion batteries can be stored from -4° F (-20° C) to 140° F (+60° C) at up to 80% relative humidity. However, they are best stored below 70° F (21° C) in a cool, dry, well-ventilated facility free from corrosive gas or vapor.

Storage at temperatures above 113° F (45° C), such as in a hot car, may degrade battery performance and reduce battery life. Storage at low temperatures may affect initial battery performance.

The optimal temperature range for charging the batteries is 0° F to 113° F (0° C to 45° C) at up to 80% relative humidity. The device will not charge the battery if the battery cells exceed 113° F (45° C). Battery charging will be inhibited until the battery temperature returns to 111° F (44° C) or below.



## **Caring for your SimplyGo Mini System**

---

### **Cleaning the Device and Rechargeable Battery**

**Warning:** To avoid electrical shock, do not remove the SimplyGo Mini covers. The covers should only be removed by authorized service personnel. Do not apply liquid directly to the covers. Do not use alcohol, solvents, polishes, or any oily substances on the device, as they are flammable.

**Caution:** Do not allow liquids into any of the controls, the interior of the case, or the oxygen tubing connector. If this occurs, contact your equipment provider for assistance.

### **Cleaning**

The exterior covers of the device and rechargeable battery should be cleaned between patient use and as needed by performing the following steps:

1. Turn the device off and disconnect from the power source before cleaning.
2. Remove the device from the carrying case.
3. If the battery is removed, wipe the battery bay and battery with a dry cloth.
4. Clean the device exterior using a damp cloth with a mild household cleaner and wipe it dry.

### **Disinfection**

The exterior covers of the device and rechargeable battery should be disinfected between patient use as follows:

1. Clean the device as indicated above.
2. Per the manufacturer's instructions, use a Discide Ultra Towelette to disinfect the exterior of the device and wipe dry.  
(Manufacturer - Palmero, [www.palmerohealth.com](http://www.palmerohealth.com) or equivalent)

## SimplyGo Mini User Manual

# Cleaning the Accessories

Follow the instructions below when cleaning the accessories.

## Carrying Case

If necessary, the carrying case can be washed in a washing machine using a mild laundry detergent. Air dry.

To wash the carrying case by hand, use only warm water and a mild liquid dish detergent:

1. Remove the SimplyGo Mini device from the carrying case.
2. Dampen a cloth in the detergent and water solution and wipe the outside surfaces of the case clean.

## AC and DC Power Supplies/Power Cord

The AC and DC power supplies and power cord should be cleaned as needed.

1. Disconnect cords from device before cleaning.
2. Disconnect the power supply from the AC or DC power source.
3. Clean the cords using a cloth with a mild household cleaner and wipe dry.

## Cannula and Tubing

Clean and replace the cannula and tubing as instructed by the manufacturer and your equipment provider.

## Device Storage

Store your device in a place where it will remain clean and dry.

**Caution:** Do not store your device or accessories in extreme temperatures, below -4° F (-20° C) or above 140° F (60° C).

## Device Disposal

Separate collection for electrical and electronic equipment per EC Directive 2012/19/EU. Dispose of this device in accordance with local regulations.

# SimplyGo Mini Portable Oxygen Concentrator

## Mobility

---

Your SimplyGo Mini system has been designed to provide you with a source of oxygen that can be carried with you. To enable you to do so, your SimplyGo Mini device has a carrying case bag with it.

### SimplyGo Mini Carrying Case

The SimplyGo Mini carrying case allows you to take your supply of oxygen with you as you go about your normal, daily activities. It provides protection for your SimplyGo Mini as well as a carrying strap to transport the device. To place the SimplyGo Mini into its carrying bag:

1. A. If you are using the device with the extended battery, unzip the bottom of the carrying case to allow for the device to easily slide into the bag.  
B. If you are only using the standard battery or AC power, you only need to unzip the side of the bag as shown below.

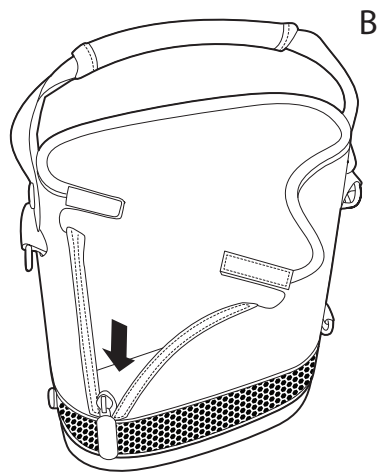
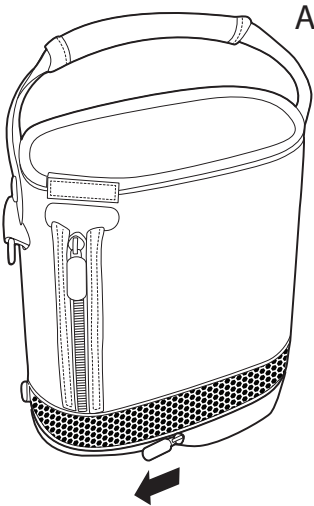

## SimplyGo Mini User Manual

2. Insert the device into the top of the bag as shown below, and pull the bag up around the device.

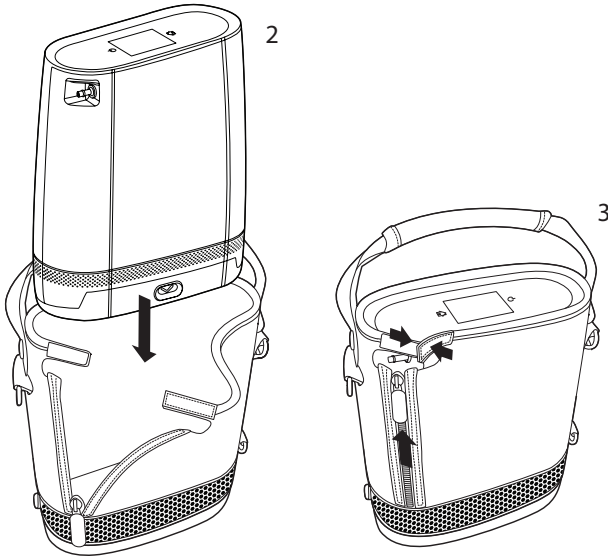

3. Zip the zipper up on the side of the bag to ensure that SimplyGo Mini is firmly installed in the bag and close the Velcro tabs. Check to ensure that the power input and cannula connectors align with their openings in the case.

## Traveling With Your System

---

With your SimplyGo Mini system and proper advance planning, you can enjoy traveling within your community and beyond. Before you leave, make sure you pack the following:

- Fully charged battery (and extra batteries for a long trip)
- AC power supply and connector cord
- DC power supply
- Carrying bag

Also, be sure to take the telephone numbers of your equipment provider and physician in case of an emergency.

**Note:** If traveling internationally, make sure you have the proper AC power cord for the country you are traveling to.

## By Motor Vehicle

Use the SimplyGo Mini DC power supply to plug in your system using the vehicle's cigarette lighter or DC power input. Whenever the SimplyGo Mini system is running from a DC power source, the battery installed in your device will begin recharging. You can also use the SimplyGo Mini device while it is running from a DC power source.

**Caution:** Make sure the vehicle has been started before plugging in your DC power supply. If you operate the SimplyGo Mini system using the DC power cord while the vehicle engine is turned off, you could inadvertently drain the vehicle's battery.

**To run the device using DC power** from an automobile or other motorized vehicle, make sure the battery is installed. Start the vehicle and connect one end of the DC Power Cord to the device's power inlet and the other end into the vehicle's DC electrical outlet.

Because the amount of current available in the vehicle electrical system is limited, the ability to charge the SimplyGo Mini battery with DC power will be determined by the operating mode of the device. DC power provided by the DC Power Supply will charge the battery when the device is turned off or is running on setting 1, 2, or 3. It may not charge the battery when the device is running on setting 4 or 5. Charging status can be verified with the battery icon on the Home Screen.

## SimplyGo Mini User Manual

### By Bus or Train

Most bus and train lines allow passengers to use portable oxygen concentrators, but you may need to notify them in advance. When you make your travel arrangements, contact your carrier well before your departure for permission to bring your system and use it on board.

**Note:** Bus and rail carriers outside the United States may have additional requirements for oxygen concentrators. Contact them several weeks before you leave to identify any requirements or specifications that may require your attention.

### On Arrival

When you arrive at your destination, check the status of your system's battery. This is an excellent time to recharge all batteries, so they're ready to go when you need them. The charge level on your batteries can be checked by following the instructions in the *Inserting and Removing the Battery* section of this manual. If a battery requires charging, this can be done as described in the *Charging the Battery with the AC Power Supply* section of this manual.

If you have any questions or concerns about traveling with your SimplyGo Mini system, contact your equipment provider.

## Specifications

Operating Conditions	Operational temperature: 5° C to 35° C (41° F to 95° F) Relative humidity: 15% to 93% Atmospheric Pressure: 700 hPa to 1010 hPa Altitude: up to 10,000 ft. (3048 m.)
Storage and Transport Conditions	-20° C to 60° C (-4° F to 140° F) - unit only Relative humidity: up to 93%, non condensing
Expected Service Life of the device and accessories	5 years

Oxygen Concentration	At least 87% at all settings (maximum of 96%) over the rated environmental range.																																																					
Flow Settings and Pulse Volumes	<table border="1"> <thead> <tr> <th rowspan="2"></th> <th colspan="5">Settings</th> </tr> <tr> <th>1</th> <th>2</th> <th>3</th> <th>4</th> <th>5</th> </tr> </thead> <tbody> <tr> <th>Breath Rate</th> <th colspan="5">Pulse Volumes (mL)</th> </tr> <tr> <td>15</td> <td>11.0</td> <td>22.0</td> <td>33.0</td> <td>44.0</td> <td>55.0</td> </tr> <tr> <td>20</td> <td>11.0</td> <td>22.0</td> <td>33.0</td> <td>44.0</td> <td>50.0</td> </tr> <tr> <td>25</td> <td>8.8</td> <td>17.6</td> <td>26.4</td> <td>35.2</td> <td>40.0</td> </tr> <tr> <td>30</td> <td>7.3</td> <td>14.7</td> <td>22.0</td> <td>29.3</td> <td>33.3</td> </tr> <tr> <td>35</td> <td>6.3</td> <td>12.6</td> <td>18.9</td> <td>25.1</td> <td>28.6</td> </tr> <tr> <td>40</td> <td>5.5</td> <td>11.0</td> <td>16.5</td> <td>22.0</td> <td>25.0</td> </tr> </tbody> </table> <p>per ISO 80601-2-67 +/-15% at STPD* +/-25% over the rated environmental range *STPD is 101.3 kPa at an operating temperature of 20 °C, dry</p>		Settings					1	2	3	4	5	Breath Rate	Pulse Volumes (mL)					15	11.0	22.0	33.0	44.0	55.0	20	11.0	22.0	33.0	44.0	50.0	25	8.8	17.6	26.4	35.2	40.0	30	7.3	14.7	22.0	29.3	33.3	35	6.3	12.6	18.9	25.1	28.6	40	5.5	11.0	16.5	22.0	25.0
	Settings																																																					
	1	2	3	4	5																																																	
Breath Rate	Pulse Volumes (mL)																																																					
15	11.0	22.0	33.0	44.0	55.0																																																	
20	11.0	22.0	33.0	44.0	50.0																																																	
25	8.8	17.6	26.4	35.2	40.0																																																	
30	7.3	14.7	22.0	29.3	33.3																																																	
35	6.3	12.6	18.9	25.1	28.6																																																	
40	5.5	11.0	16.5	22.0	25.0																																																	
Breathing Frequency	Up to 40 BPM																																																					
Inspiratory Trigger Sensitivity	≤ 0.2 cm H <sub>2</sub> O																																																					
User Interface	Capacitive Touch Screen																																																					

**SimplyGo Mini User Manual**

Dimensions	23.9 cm x 21.1 cm x 9.1 cm (standard battery) (9.4 in x 8.3 in x 3.6 in) 25.9 cm x 21.1 cm x 9.1 cm (extended battery) (10.2 in x 8.3 in x 3.6 in)
Weight	2.3 kg (5.0 lbs) with standard battery installed 2.7 kg (6 lbs) with extended battery installed
Sound Level	42 dBA typical at setting 2 and 20 BPM 48 dBA typical at setting 5 and 20 BPM (when measured at 1 m from front of device)  Maximum Sound Power of 63 dBA and Maximum Sound Pressure level of 55 dBA per ISO 80601-2-69
Audio Alarm	45 dBA or greater
Maximum Outlet Pressure	20 psig

**SimplyGo Mini Battery**

Chemistry	Lithium Ion 14.4 VDC (nominal)
Battery Options	Standard Battery Extended Battery (equals 2 standard batteries)
Dimensions	20.1 cm x 9.1 cm x 2.5 cm (standard battery) (7.9 in x 3.6 in x 1.0 in)  20.1 cm x 9.1 cm x 4.8 cm (extended battery) (7.9 in x 3.6 in x 1.9 in)
Weight	0.50 kg (1.1 lbs) (standard battery) 0.95 kg (2.1 lbs) (extended battery)
Watt-hour Rating Per Standard Battery	3.4 Ah x 3.6 V x 8 cells = 97.9 Wh



**SimplyGo Mini User Manual**

Battery Duration	Up to 4.5 hours (Pulse setting of 2 at 20 BPM with Standard battery) Up to 9 hours (Pulse setting of 2 at 20 BPM with Extended battery)
* Battery Duration times are based on new, fully charged batteries used with a new SimplyGo Mini system. Battery duration times will degrade with battery age, environmental operating conditions, use over time, and operational condition of the concentrator.	
Charge Time	Maximum recharge time is 4 hours for the standard battery and 8 hours for the extended battery from fully discharged to fully charged, depending on the power source and usage.

**AC Power**

Type	Philips Respironics REF 1116818
Input	100 to 240 VAC, 50/60 Hz
Output	19 VDC, 6.3 A max
Power Consumption	120 W while charging

**DC Power**

Type	Philips Respironics REF 1116819
Input	12-16 VDC
Output	19 +/- 5% VDC, 6.3 A

**Standards Compliance**

The device is designed to conform to the following standards

- IEC 60601-1-2, 4th edition, Medical Electrical Equipment, Part 1-2: General Requirement for Safety – Collateral Standard: Electromagnetic (EMC) Compatibility – Requirements and tests.
- IEC 60601-1 3rd edition, Medical Electrical Equipment, Part 1: General Requirements for Safety

## SimplyGo Mini User Manual

- IEC 60601-1-8 Medical electrical equipment – Part 1-8: General Requirements for Basic Safety and Essential Performance – Collateral Standard: General requirements, tests, and guidance for alarm systems in medical electrical equipment and medical electrical systems
- IEC 60601-1-11 Medical electrical equipment – Part 1-11: General Requirements for Basic Safety and Essential Performance – Collateral Standard: Requirements for medical electrical equipment and medical electrical systems used in the home healthcare environment
- ISO 10993-1, Biological Evaluation of Medical Devices, Part 1: Evaluation and Testing (Biocompatibility)
- ISO 18779, Medical Devices for Conserving Oxygen and Oxygen Mixtures: Particular Requirements
- ISO 80601-2-67, Medical electrical equipment, Part 2-67: Particular requirements for basic safety and essential performance of oxygen-conserving equipment
- ISO 80601-2-69, Medical electrical equipment, Part 2-69: Particular requirements for basic safety and essential performance of oxygen concentrator equipment

## Classification

The SimplyGo Mini is classified as:

- IEC Class II Internally Powered Equipment
- Type BF Applied Part
- IP22: Drip Proof Equipment
- Not suitable for use in the presence of a flammable anesthetic mixture with air or with oxygen or nitrous oxide.
- Continuous Operation

## EMC Information

Your unit has been designed to meet EMC standards throughout its Service Life without additional maintenance. There is always an opportunity to relocate your portable SimplyGo Mini within an environment that contains other devices with their own unknown EMC behavior. If you believe your unit is affected by locating it closer to another device, simply separate the devices to remove the condition.

### Portable Oxygen Concentrator

The SimplyGo Mini is designed to provide enriched oxygen. If there is a condition where the device is not providing enriched oxygen, the device will alarm.

### Oxygen Conserving

The SimplyGo Mini is designed to provide oxygen in response to the patient's breathing. The device includes a sensing circuit that will detect when the patient has started to inhale. If the SimplyGo Mini is either randomly or not providing pulse dosed oxygen, this is a sign that the detection sensor is currently having trouble detecting the patient's breathing pattern.

If there are errors or alarms affecting the purity or conserving features of the device, the user should attempt to move the SimplyGo Mini to a different area to determine if the issue is due to electromagnetic interference with other equipment in the vicinity.

Guidance and Manufacturer's Declaration – Electromagnetic Emissions		
SimplyGo Mini is intended for use in the electromagnetic environment specified below. The user of SimplyGo Mini should assure that it is used in such an environment.		
Emissions Test	Compliance	Electromagnetic Environment - Guidance
RF Emissions CISPR 11	Group 1	The Device uses RF energy only for its internal function. Therefore, its RF emissions are very low and are not likely to cause any interference in nearby electronic equipment.
RF Emissions CISPR 11	Class B	The Device is suitable for use in all establishments, including domestic establishments and those directly connected to the public low-voltage power supply network that supplies buildings used for domestic purposes.
Harmonic Emissions IEC 61000-3-2	Class A	
Voltage Fluctuations/Flicker Emissions IEC 61000-3-3	Complies	
RF Emissions CISPR25		The Device is suitable for use in vehicles and boats.

Guidance and Manufacturer's Declaration – Electromagnetic Immunity			
SimplyGo Mini is intended for use in the electromagnetic environment specified below. The user of SimplyGo Mini should assure that it is used in such an environment.			
Immunity Test	IEC 60601 Test Level	Compliance Level	Electromagnetic Environment - Guidance
Electrostatic Discharge (ESD) IEC 61000-4-2	±8 kV Contact ±15 kV Air	±8 kV Contact ±15 kV Air	Floors should be wood, concrete or ceramic tile. If floors are covered with synthetic material, the relative humidity should be at least 30%.

## SimplyGo Mini User Manual

Electrical Fast Transient/Burst IEC 61000-4-4	$\pm 2$ kV for Power Supply Lines $\pm 1$ kV for Input/Output Lines	$\pm 2$ kV for Power Supply Lines $\pm 1$ kV for Input/Output Lines	Mains power quality should be that of a typical home or hospital environment.
Electrical Transient Conduction along supply lines ISO 7637-2	As specified in ISO 7637-2	As specified in ISO 7637-2	The Device is suitable for use in vehicles and boats.
Surge IEC 61000-4-5	$\pm 1$ kV Line to Line $\pm 2$ kV Line to Ground	$\pm 1$ kV Line to Line $\pm 2$ kV Line to Ground	Mains power quality should be that of a typical home or hospital environment.
Voltage Dips, Short Interruptions and Voltage Variations on Power Supply Input Lines IEC 61000-4-11	<5% $U_i$ (>95% Dip in $U_i$ ) for 0.5 Cycle at 45 degree increments  70% $U_i$ (30% Dip in $U_i$ ) for 0.5 seconds  <5% $U_i$ (>95% Dip in $U_i$ ) for 5 Seconds	<5% $U_i$ (>95% Dip in $U_i$ ) for 0.5 Cycle at 45 degree increments  70% $U_i$ (30% Dip in $U_i$ ) for 0.5 seconds  <5% $U_i$ (>95% Dip in $U_i$ ) for 5 Seconds	Mains power quality should be that of a typical home or hospital environment. If the user of the Device required continued operation during power mains interruptions, it is recommended that the Device be powered from an uninterruptible power supply or battery.
Power Frequency (50/60 Hz) Magnetic Field IEC 61000-4-8	30 A/m	30 A/m	Power frequency magnetic fields should be at levels characteristic of a typical location in a typical home or hospital environment.
Note: $U_i$ is the A.C. mains voltage prior to application of the test level.			

Guidance and Manufacturer's Declaration – Electromagnetic Immunity			
SimplyGo Mini is intended for use in the electromagnetic environment specified below. The user of SimplyGo Mini should assure that it is used in such an environment.			
Immunity Test	IEC 60601 Test Level	Compliance Level	Electromagnetic Environment - Guidance
Conducted RF IEC 61000-4-6	3 Vrms 150 kHz to 80 MHz	3 Vrms 150 kHz to 80 MHz	Portable and mobile RF communications equipment should be used no closer to any part of the Device, including cables, than the recommended 30 cm separation distance.
Radiated RF IEC 61000-4-3	6 Vrms Amateur Radio & ISM Bands between 150 kHz and 80 MHz	6 Vrms Amateur Radio & ISM Bands between 150 kHz and 80 MHz	
Radiated RF IEC 61000-4-3	10 V/m  80 MHz to 2.7 GHz	10 V/m	
			Interference may occur in the vicinity of equipment marked with the following symbol:  

## **Limited Warranty**

---

Respironics, Inc. ("Respironics") warrants the SimplyGo Mini Portable Oxygen Concentrator System (the "Product") as set forth in the following paragraphs.

Respironics warrants that the Product, except as otherwise stated herein, is free from defects in materials and workmanship under normal and proper use and when correctly maintained in accordance with applicable instructions, for a period equal to the warranty period purchased with the device, or if not otherwise specified, for a period of three (3) years from the date of shipment.

Respironics warrants the Sieve Bed assembly within the Product is free from defects in materials and workmanship under normal and proper use and when correctly maintained in accordance with applicable instructions, for a period equal to the warranty period purchased with the device, or if not otherwise specified, for a period of twelve (12) months from the date of shipment.

### Products Not Under Warranty

Accessories and replacement parts, including, but not limited to, filters and fuses, are not covered under this warranty. However, Respironics warrants that the battery in the Product will be free from defects in material and workmanship, under normal and proper use and when correctly maintained in accordance with applicable instructions, for a period of 90 days from the date of shipment by Respironics to the original purchaser. This warranty does not apply to batteries that are dropped, misused, altered or otherwise damaged after they are shipped.

### Limitations

If any Product purchased from Respironics fails to conform to the warranties set forth herein during the Warranty Period, as determined by Respironics in its sole discretion, Respironics may discharge its warranty obligation by repairing or replacing the Product, in Respironics' sole discretion. This may be accomplished by installing new or remanufactured assemblies or components, or by other repairs deemed appropriate in the sole discretion of Respironics. The choice of repair or replacement by Respironics shall be the sole and exclusive remedy of the original purchaser. Respironics reserves the right, in its sole discretion, to refund the purchase price in lieu of repair or replacement of the Product. In no event shall Respironics' maximum liability under these warranties exceed the price paid to Respironics by the original purchaser for the Product.

### Conditions

This warranty does not cover damage or injury whether to the Product or to personal property or persons caused by accident, misuse, abuse, negligence, failure to install in accordance with Respironics' installation instructions, failure to operate under conditions of normal use and in accordance with the terms of the operating manual and instructions, failure to maintain in accordance with the applicable service manuals, or alteration or any defects not related to materials or workmanship of the Product. This warranty does not cover damage which may occur in shipment. This warranty does not apply to any Product or individual part of a Product that may have been repaired or altered by anyone other than Respironics or an authorized Respironics service center. This warranty does not apply to any Product which is not purchased new.

## SimplyGo Mini User Manual

### Exclusions of Warranties

EXCEPT AS SET FORTH IN THIS LIMITED WARRANTY, RESPIRONICS MAKES NO WARRANTIES, EXPRESSED OR IMPLIED, STATUTORY OR OTHERWISE, REGARDING THE PRODUCT, ITS QUALITY OR PERFORMANCE. RESPIRONICS SPECIFICALLY DISCLAIMS THE IMPLIED WARRANTY OF MERCHANTABILITY AND THE IMPLIED WARRANTY OF FITNESS FOR A PARTICULAR PURPOSE. IN NO EVENT SHALL RESPIRONICS BE LIABLE FOR THE COST OF PROCUREMENT OF SUBSTITUTE PRODUCTS OR FOR ANY INDIRECT, SPECIAL, CONSEQUENTIAL, PUNITIVE, EXEMPLARY OR INCIDENTAL DAMAGES (INCLUDING, BUT NOT LIMITED TO, COMMERCIAL LOSS OR LOST REVENUES), FOR ANY CAUSE OF ACTION, WHETHER IN CONTRACT OR TORT, AND WHETHER OR NOT RESPIRONICS WAS AWARE OR SHOULD HAVE BEEN AWARE OF THE POSSIBILITY OF THESE DAMAGES. EXCEPT FOR THE OBLIGATIONS UNDER THIS LIMITED WARRANTY, RESPIRONICS SHALL NOT HAVE ANY OBLIGATION OR LIABILITY FOR ANY OTHER LOSS, DAMAGE OR INJURY RESULTING DIRECTLY OR INDIRECTLY FROM THE PRODUCT. PURCHASER'S SOLE AND EXCLUSIVE REMEDY FOR BREACH OF THE WARRANTIES SET FORTH IN THIS DOCUMENT SHALL BE AS PROVIDED IN THE PARAGRAPH DESCRIBING LIMITATIONS.

Purchaser is cautioned that no person or entity is authorized to make any warranties on behalf of Respironics and any such alleged warranties are hereby disclaimed by Respironics.

**Note: For Australian and New Zealand customers this warranty replaces the warranty contained above.**

1. Respironics, Inc., a Philips Healthcare company warrants that the Products shall be free from defects of workmanship and materials and will perform in accordance with the Product specifications. 2. For the SimplyGo Mini Portable Oxygen Concentrator System, this warranty is valid for a period of three (3) years from the date of purchase from an authorised Respironics dealer, except that for the sieve bed assembly within the SimplyGo Mini Portable Oxygen Concentrator System; this warranty is valid for a period of twelve (12) months from the date of purchase from an authorised Respironics dealer. 3. If the Product is found to contain a defect of workmanship or materials or fails to perform in accordance with the Product specifications during the applicable warranty period, Respironics will repair or replace, at its option, the defective material or part. 4. The customer is responsible for returning the product to an authorised Philips Respironics dealer, and collecting the product from the authorised Philips Respironics dealer after repair or replacement, at its own cost. Philips Respironics is responsible only for the freight cost of transporting the product between the authorised Philips Respironics dealer and Respironics. Respironics reserves the right to charge an evaluation and postage fee for any returned Product as to which no problem is found following investigation. 5. This warranty does not cover damage caused by accident, misuse, abuse, alteration, and other defects not related to materials or workmanship. 6. The warranty provided by Respironics herein is not transferrable by the Buyer in the event of any sale or transfer of Products purchased by the Buyer from an authorised Respironics dealer. 7. To the extent permitted by law, where the Buyer has the benefit of an implied guarantee under the Australian Consumer Law, but the Product is not of a kind ordinarily acquired for personal, domestic or household use or consumption Respironics' liability shall be limited, at the option of Respironics, to the replacement or repair of the Product or the supply of an equivalent Product. 8. To exercise your rights under this warranty, contact your local authorised Philips Respironics dealer. A list of all authorised dealers is available at the following link: <http://www.philips.com.au/healthcare>.

Alternatively, you can make a claim under this warranty by contacting Respironics directly at: Philips Electronics Australia Limited, 65 Epping Road, North Ryde NSW 2113, Australia. Tel: 1 300 766 488, Email: [prcontact@philips.com](mailto:prcontact@philips.com). 9. The following statement is provided to a Buyer who is a "consumer" under the Australian Consumer Law: Our goods come with guarantees that cannot be excluded under the Australian Consumer Law. You are entitled to a replacement or refund for a major failure and for compensation for any other reasonably foreseeable loss or damage. You are also entitled to have the good repaired or replaced if the goods fail to be of acceptable quality and the failure does not amount to a major failure. 10. The following statement is provided to a Buyer who is a "consumer" under the Consumer Guarantees Act 1993, New Zealand: Our goods come with guarantees that cannot be excluded under the Consumer Guarantees Act 1993. This guarantee applies in addition to the conditions and guarantees implied by that legislation.

**PHILIPS**  
RESPIRONICS

SimplyGo Mini



Respironics Inc.  
1001 Murry Ridge Lane  
Murrysville, PA 15668 USA

Respironics Deutschland  
Gewerbestr. 17  
82211 Herrsching, Germany



REF 1121830

1121829 R02  
JH 08/13/2015  
EN-INTL



User Manual